

# Modeling of a UHF RFID Tag

## Introduction

---

UHF RFID tags are widely used for identifying and tracking animals. This example simulates a passive radio-frequency identification (RFID) tag for the UHF frequency range.

With respect to the chip transponder's complex impedance, a reflection coefficient is computed. This is done using an approach that differs from the conventional scattering parameter analysis method by a real reference impedance value.

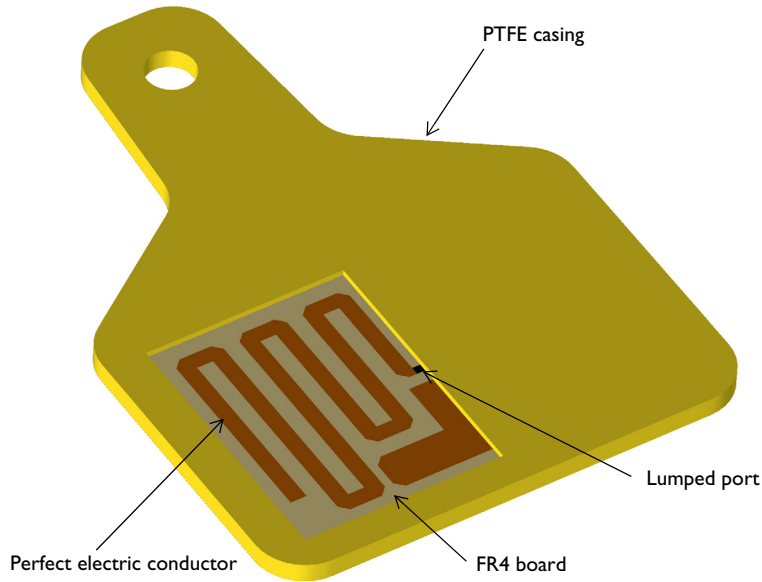

*Figure 1: The RFID tag's geometry consists of copper traces patterned on an FR4 board that is enclosed by a low dielectric PTFE case. The surrounding air domain and perfectly matched layers, which are required for the simulation, are not included in this figure.*

## Model Definition

---

In this example, the RFID tag's operating frequency is 915 MHz. At this frequency, the metal part of the RFID tag can be modeled as a perfect electrical conductor (PEC), because while the copper traces patterned on the FR4 board are geometrically very thin, they are much thicker than the skin depth.

The entire circuit board is inserted inside a lossless PTFE casing. The tag is modeled in a spherical air domain, which is enclosed by perfectly matched layers (PML) that absorb all outgoing radiation from the tag.

A lumped port with a reference impedance of  $50 \Omega$  is used on the location of an RFID chip. This is done to excite the tag and evaluate the input impedance of the tag's antenna part, which is modeled as a meander line. An additional copper strip is placed adjacent to the meander line to control the impedance.

The conventional S-parameter works well only with a real reference impedance. However, the RFID chip's impedance is complex and the calculated S-parameter is not physical when a complex port reference impedance is used.

In Ref. 1, the power wave reflection coefficient term is introduced. It is applicable for evaluating the matching properties of an RFID tag:

$$\Gamma = \frac{Z_l - Z_{\text{ref}}^*}{Z_l + Z_{\text{ref}}}$$

where  $Z_l$  is the complex load impedance and  $Z_{\text{ref}}$  is the complex reference impedance.

### *Results and Discussion*

---

Figure 2 shows the default E-field norm on the  $xy$ -plane. The field distribution plot indicates that the electric field is symmetrically confined along the meander line, as well as in the area between the meander line and impedance matching strip.

The far-field radiation pattern of the tag is shown in Figure 3. Noticeably, the tag's radiation pattern looks very similar to the radiation pattern of a half-wave dipole antenna.

The evaluated impedance of the tag is around  $17 + j124 \Omega$  and the power wave reflection coefficient, in dB, is below  $-15$  dB.

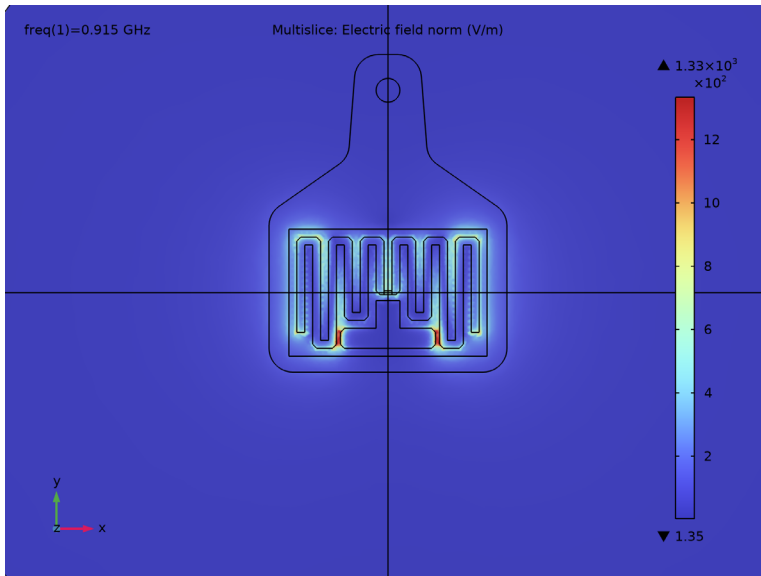

Figure 2: The E-field norm plot shows where the field is strongly confined in the tag.

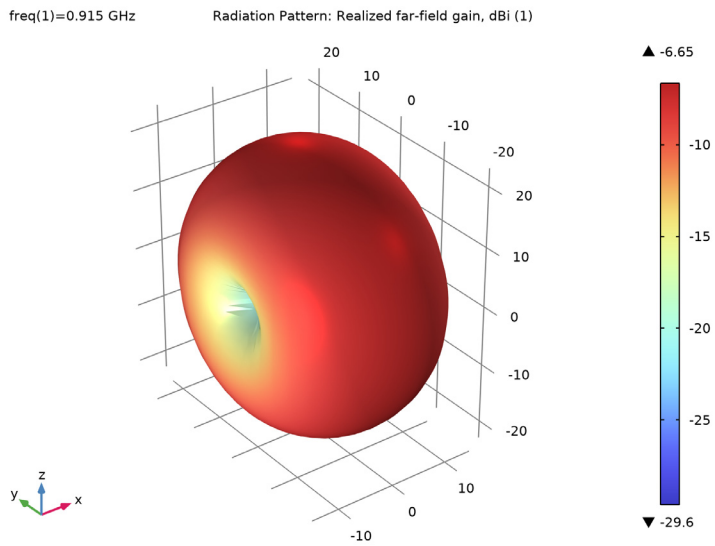

Figure 3: The far-field radiation pattern resembles that of a half-wave dipole antenna.

## Reference

---

1. K. Kurokawa, "Power Waves and the Scattering Matrix," *IEEE Transactions on Microwave Theory and Techniques*, Volume 13, 1965.

---

**Application Library path:** RF\_Module/Antennas/uhf\_rfid\_tag

---

## Modeling Instructions



---

From the **File** menu, choose **New**.

### NEW

In the **New** window, click  **Model Wizard**.

### MODEL WIZARD

- 1 In the **Model Wizard** window, click  **3D**.
- 2 In the **Select Physics** tree, select **Radio Frequency > Electromagnetic Waves, Frequency Domain (emw)**.
- 3 Click **Add**.
- 4 Click  **Study**.
- 5 In the **Select Study** tree, select **General Studies > Frequency Domain**.
- 6 Click  **Done**.

### STUDY I

#### *Step 1: Frequency Domain*

Define the study frequency ahead of performing any frequency-dependent operation such as building mesh. The physics-controlled mesh uses the specified frequency value.

- 1 In the **Model Builder** window, under **Study I** click **Step 1: Frequency Domain**.
- 2 In the **Settings** window for **Frequency Domain**, locate the **Study Settings** section.
- 3 In the **Frequencies** text field, type 915[MHz].

### GLOBAL DEFINITIONS

#### *Parameters 1*

- 1 In the **Model Builder** window, under **Global Definitions** click **Parameters 1**.



- 2 In the **Settings** window for **Parameters**, locate the **Parameters** section.
- 3 In the table, enter the following settings:

Name	Expression	Value	Description
Zc	$15 - j * 125 [\text{ohm}]$	$(15 - 125i) \Omega$	Chip impedance

## GEOMETRY I

- 1 In the **Model Builder** window, under **Component 1 (comp1)** click **Geometry 1**.
- 2 In the **Settings** window for **Geometry**, locate the **Units** section.
- 3 From the **Length unit** list, choose **mm**.

### Import 1 (imp1)

- 1 In the **Geometry** toolbar, click  **Import**.
- 2 In the **Settings** window for **Import**, locate the **Source** section.
- 3 Click  **Browse**.
- 4 Browse to the model's Application Libraries folder and double-click the file `uhf_rfid_tag.mphbin`.
- 5 Click  **Import**.
- 6 Click the  **Wireframe Rendering** button in the **Graphics** toolbar.

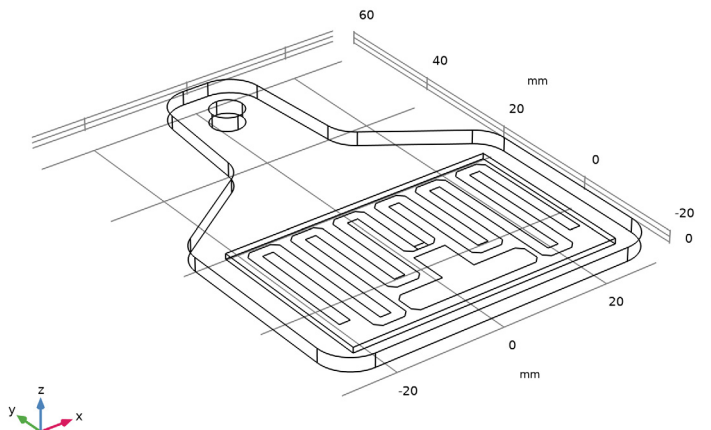



Add a sphere for the air domain surrounding the RFID tag and perfectly matched layers that will be configured later on.

### Sphere 1 (sph1)

- 1 In the **Geometry** toolbar, click  **Sphere**.
- 2 In the **Settings** window for **Sphere**, locate the **Size** section.
- 3 In the **Radius** text field, type 150.
- 4 Click to expand the **Layers** section. In the table, enter the following settings:

Layer name	Thickness (mm)
Layer 1	30

- 5 Click  **Build All Objects**.
- 6 Click the  **Zoom Extents** button in the **Graphics** toolbar.

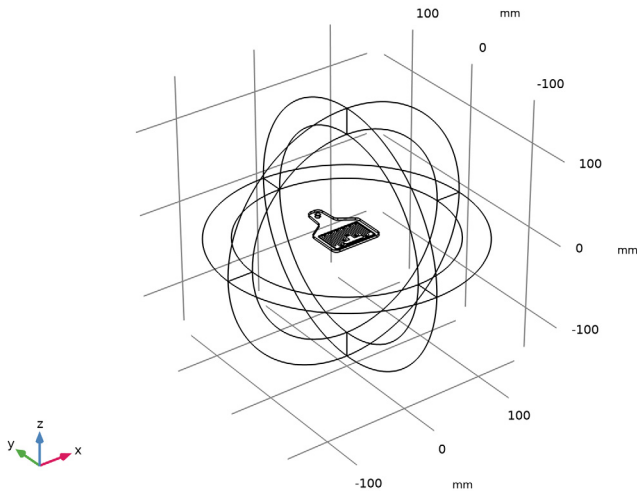

## DEFINITIONS

### Variables 1

- 1 In the **Model Builder** window, under **Component 1 (comp1)** right-click **Definitions** and choose **Variables**.  
Define a variable for calculating the reflection coefficient between two complex impedances.
- 2 In the **Settings** window for **Variables**, locate the **Variables** section.

3 In the table, enter the following settings:

Name	Expression	Unit	Description
Gamma	$(emw.Zport\_1 - \text{conj}(Zc)) / (emw.Zport\_1 + Zc)$		Reflection coefficient for complex impedance matching

*Perfectly Matched Layer 1 (pml1)*

1 In the **Definitions** toolbar, click  **Perfectly Matched Layer**.

2 Select Domains 1–4 and 9–12 only.

These are all of the outermost domains of the sphere.

3 In the **Settings** window for **Perfectly Matched Layer**, locate the **Geometry** section.

4 From the **Type** list, choose **Spherical**.

## ELECTROMAGNETIC WAVES, FREQUENCY DOMAIN (EMW)

*Perfect Electric Conductor 2*

1 In the **Physics** toolbar, click  **Boundaries** and choose **Perfect Electric Conductor**.

2 Click the  **Zoom In** button in the **Graphics** toolbar, a couple of times to get a clear view of the RFID tag.

3 Select Boundaries 25, 27, and 54 only.

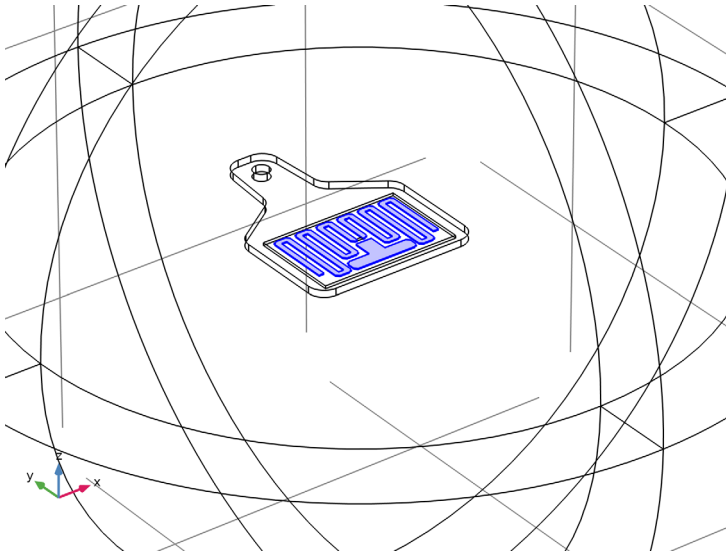





### *Lumped Port 1*

- 1 In the **Physics** toolbar, click  **Boundaries** and choose **Lumped Port**.
- 2 Select Boundary 35 only.



For the first port, wave excitation is **on** by default.

- 3 Click the  **Zoom Extents** button in the **Graphics** toolbar.
- 4 Click the  **Zoom In** button in the **Graphics** toolbar.

### *Far-Field Domain 1*

In the **Physics** toolbar, click  **Domains** and choose **Far-Field Domain**.

## **ADD MATERIAL**

- 1 In the **Materials** toolbar, click  **Add Material** to open the **Add Material** window.
- 2 Go to the **Add Material** window.
- 3 In the tree, select **Built-in** > **Air**.
- 4 Click the **Add to Component** button in the window toolbar.
- 5 In the tree, select **Built-in** > **FR4 (Circuit Board)**.
- 6 Click the **Add to Component** button in the window toolbar.
- 7 In the **Materials** toolbar, click  **Add Material** to close the **Add Material** window.

## **MATERIALS**

### *FR4 (Circuit Board) (mat2)*

Select Domain 7 only.

### *Material 3 (mat3)*

- 1 In the **Model Builder** window, right-click **Materials** and choose **Blank Material**.
- 2 Select Domain 6 only.
- 3 In the **Settings** window for **Material**, locate the **Material Contents** section.

4 In the table, enter the following settings:

Property	Variable	Value	Unit	Property group
Relative permittivity	epsilon <sub>r_</sub> iso ; epsilon <sub>r_</sub> ii = epsilon <sub>r_</sub> iso, epsilon <sub>r_</sub> ij = 0	2.1		Basic
Relative permeability	mu <sub>r_</sub> iso ; mu <sub>r_</sub> ii = mu <sub>r_</sub> iso, mu <sub>r_</sub> ij = 0	1		Basic
Electric conductivity	sigma <sub>iso</sub> ; sigma <sub>ii</sub> = sigma <sub>iso</sub> , sigma <sub>ij</sub> = 0	0	S/m	Basic

#### MESH 1

In the **Model Builder** window, under **Component 1 (comp1)** right-click **Mesh 1** and choose **Build All**.

To see the meshed structure of the device, remove some boundaries from the view.

#### DEFINITIONS

*Hide for Physics 1*

- 1 In the **Model Builder** window, right-click **View 1** and choose **Hide for Physics**.
- 2 In the **Settings** window for **Hide for Physics**, locate the **Geometric Entity Selection** section.
- 3 From the **Geometric entity level** list, choose **Boundary**.
- 4 Select Boundaries 6, 10, 16, 37, 40, and 42 only.

## MESH 1

In the **Model Builder** window, under **Component 1 (comp1)** click **Mesh 1**.

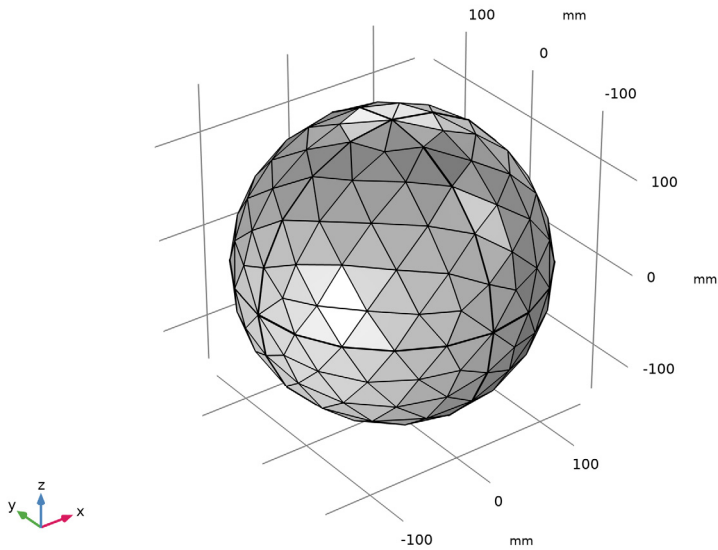

## STUDY 1

*Step 1: Frequency Domain*

In the **Study** toolbar, click  **Compute**.

## RESULTS

*Multislice*

**1** In the **Model Builder** window, expand the **Electric Field (emw)** node, then click **Multislice**.

**2** In the **Settings** window for **Multislice**, locate the **Multiphase Data** section.

**3** Find the **X-planes** subsection. In the **Planes** text field, type 0.

**4** Find the **Y-planes** subsection. In the **Planes** text field, type 0.

**5** In the **Electric Field (emw)** toolbar, click  **Plot**.

**6** Click the  **Go to XY View** button in the **Graphics** toolbar.

Zoom in a couple of time to get a good view of the RFID tag.

Compare the reproduced plot with [Figure 2](#).

*Electric Field, Logarithmic (emw)*

In the **Model Builder** window, under **Results** click **Electric Field, Logarithmic (emw)**.

freq(1)=0.915 GHz Surface: 1 (1) Multislice: Electric field norm (V/m) Surface: Electric field norm (V/m)

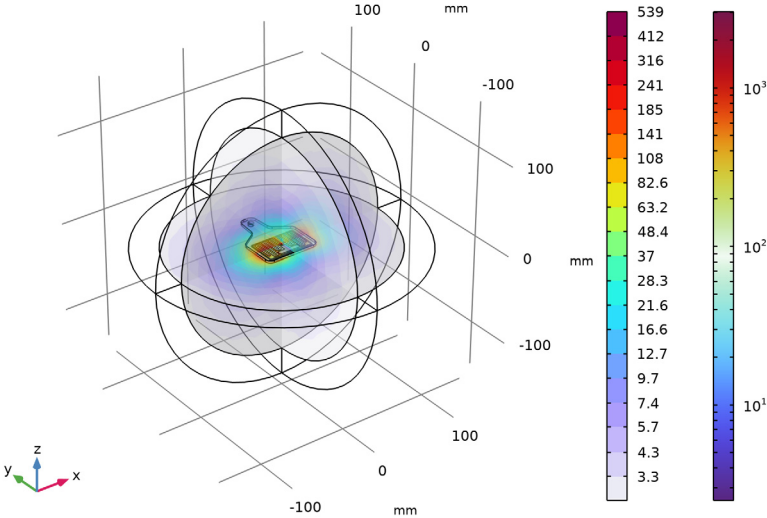

## 2D Far Field (emw)

1 In the **Model Builder** window, click **2D Far Field (emw)**.

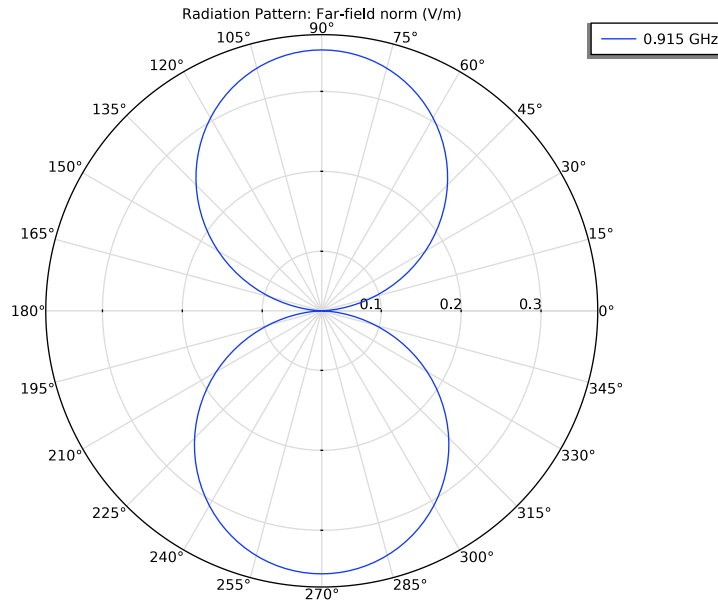

The E-plane radiation pattern resembles that of a dipole antenna.

### Radiation Pattern 1

- 1 In the **Model Builder** window, expand the **3D Far Field, Gain (emw)** node, then click **Radiation Pattern 1**.
- 2 In the **Settings** window for **Radiation Pattern**, locate the **Evaluation** section.
- 3 Find the **Angles** subsection. In the **Number of azimuth angles** text field, type 40.
- 4 In the **3D Far Field, Gain (emw)** toolbar, click  **Plot**.

## DIRECTIVITY

1 Go to the **Directivity** window.

Reproduce [Figure 3](#).

## RESULTS

### Global Evaluation 2

1 In the **Results** toolbar, click  **Global Evaluation**.

- 2 In the **Settings** window for **Global Evaluation**, click **Replace Expression** in the upper-right corner of the **Expressions** section. From the menu, choose **Component 1 (comp1) > Electromagnetic Waves, Frequency Domain > Ports > emw.Zport\_1 - Lumped port 1 impedance -  $\Omega$** .

- 3 Click  **Evaluate**.

### *Global Evaluation 3*

- 1 In the **Results** toolbar, click  **Global Evaluation**.
- 2 In the **Settings** window for **Global Evaluation**, locate the **Expressions** section.
- 3 In the table, enter the following settings:

Expression	Unit	Description
$20 * \log_{10}(\text{abs}(\text{Gamma}))$		

- 4 Click  **Evaluate**.