

# Use of COMSOL<sup>®</sup> AC/DC module to model an EM sensor deployed to monitor steel transformation during cooling from elevated temperatures

Jialong Shen<sup>a,\*</sup>, Will Jacobs<sup>a</sup>, Lei Zhou<sup>a</sup>, Peter Hunt<sup>b</sup> and Claire Davis<sup>a</sup>

<sup>a</sup> Advanced Steel Research Centre, WMG, University of Warwick, Coventry, CV4 7AL, UK

<sup>b</sup> Primetals Technologies Limited, 9 Aviation Way, Christchurch, BH23 6EW

\*Corresponding author: shenjialong2012@gmail.com

**Abstract:** Electromagnetic (EM) sensors (using EMspec<sup>™</sup> technology) have recently been installed in the run out table of a hot strip steel mill to monitor microstructure transformation on cooling after hot rolling, as this determines the mechanical properties required by customers. EM sensors can be used to measure microstructure by detecting the changes in the materials magnetic and electric properties using the known relationships between permeability and resistivity with microstructure and temperature. A full 3D FE model using COMSOL Multiphysics<sup>®</sup> has been developed to allow the EM sensor output (Zero Crossing Frequency, ZCF) to be quantitatively related to the steel microstructure (phase fraction) at room temperature and elevated temperatures. Magnetic field interface and frequency domain studies were used to calculate the sensor inductance response to the microstructure change, from which the ZCF can be determined. Mesh optimization was applied to improve the signal accuracy for high frequencies (>12000 Hz). The challenges overcome were in the validation of the room temperature sensor model taking into account the sensor design and in-built signal processing and then specifically in the model configuration and optimisation to correctly represent high permeability/resistivity steels considering a range of operating frequencies, which required use of the COMSOL software features in the AC/DC module of boundary layer mesh, parametric and auxiliary sweep.

**Keywords:** Electromagnetic sensor, FE modelling, magnetic field, boundary layer, microstructure

## 1. Introduction

Real-time microstructure monitoring is important during the cooling process for hot-rolled strip steel production (as shown in Figure 1), as the microstructure formed determines the mechanical properties required by customers. The materials magnetic and electric properties, relative permeability and resistivity respectively, are related to the steel microstructure and hence changes in these can be used to characterise the phase transformation during steel strip cooling [1, 2]. Electromagnetic (EM) sensors have been extensively used to characterise steel at room temperature and different approaches have been used to quantify the relationship between EM sensor signal and microstructure, including empirical and FE modelling approaches [3, 4]. A new low magnetic field EM sensor system, using EMspec<sup>™</sup> technology, has been developed that can monitor steel microstructure at elevated temperatures (below the Curie temperature of approx. 760°C) in the production environment taking advantage of the system being non-contact, inexpensive, having a fast response and being unaffected by water and the surrounding high temperature environment. To fully exploit this system there is a need to be able to quantitatively relate the signal to the

microstructure taking into account the high temperature characteristics of the material and industrial sensor design, which has not been previously reported.

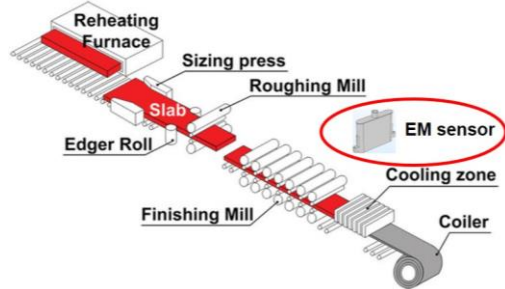

**Figure 1. Schematic diagram of the hot strip rolling process with an EM sensor working in the cooling zone for microstructure monitoring (revised based on [5]).**

In this paper, a 3D FE model for the commercial electromagnetic sensor system using EMspec™ technology, has been developed using the AC/DC module in COMSOL Multiphysics®. The physics of magnetic fields and frequency domain study were used in the model. The multi-turn coil feature was assigned to the exciting and sensing coils with coil geometry analysis. Experimental measurements using the commercial sensor and steel samples at room temperature and during cooling after reheating to 900°C were carried out to validate the modelling approach.

## 2. The EMspec™ system

The EMspec™ sensor consists of an H shaped non-conducting ferrite core, with 1 exciting coil and 2 sensing coils (1 active, 1 dummy), as shown in Figure 2. The sensor head is normally set in a ferritic stainless canister, which is used to protect the sensor head from the environment (high temperature and humidity), from damage during use in the hot strip mill and also to shield the sensor from signals produced by other metallic components or operating equipment. The sensor is installed between the rollers of the steel strip mill run out table (ROT) and is able to monitor the steel phase transformation during the cooling

process. The active sensing coil detects the voltage induced in the steel by the exciting coil while the dummy coil combined with the sensing coil zeros the signal when there is no sample present (the dummy coil effectively measures the canister protecting the sensor). The inductance versus frequency spectrum, which is affected by both the steel permeability and resistivity, is calculated by a digital signal processor (DSP) based on a fast Fourier transform of the excitation current and the induced voltage [2]. The zero-crossing frequency (ZCF) deduced from the inductance phase spectra is the signal used for this system, as it has relatively low sensitivity to any changes in lift off (from the set point of 40 mm) between the steel and sensor on the ROT.

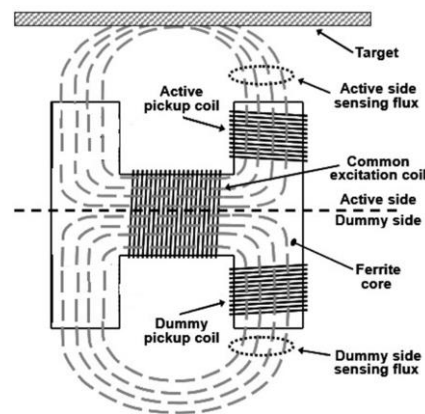

**Figure 2. Schematic diagram of an H shaped sensor [2].**

## 3. The application of COMSOL Multiphysics

### 3.1 Governing equations

The sensor FE model was developed in the AC/DC module using the magnetic fields interface with a frequency domain study, which allows a study of the relationship between sensor signals and permeability / resistivity of the steel sample. The model is based on solving Maxwell's equations using certain boundary conditions, which can be written as [6]

$$\begin{aligned}(j\omega\sigma - \omega^2\epsilon_0\epsilon_r)A + \nabla \times H &= J_e \\ (\mu_0^{-1}\mu_r^{-1}B) &= H \\ \nabla \times A &= B\end{aligned}$$

Where  $A$  is the magnetic vector potential,  $H$  is magnetic field,  $J_e$  is external current density,  $\omega$  is angular frequency,  $B$  is magnetic flux density,  $\epsilon_0$ ,  $\epsilon_r$  are vacuum and relative permittivity respectively and  $\mu_0$ ,  $\mu_r$  are vacuum and relative permeability respectively.

The boundary conditions used in the model describing relationships between two media in an AC power electromagnetic problem can be expressed as

$$n \times A = 0$$

Where  $n$  is normal vector and  $A$  is magnetic vector potential. The magnetic insulation boundary is applied to the symmetry planes of the model domain as it sets the tangential component of the magnetic potential  $A$  to zero. The inductance derived from the model can be expressed as

$$L_r = \text{real}(mf.VCoil_e / (mf.ICoil_s \times mf.\omega \times 1j))$$

$$L_i = \text{imag}(mf.VCoil_e / (mf.ICoil_s \times mf.\omega \times 1j))$$

Where  $L_r$  and  $L_i$  are the real and imaginary part of the inductance respectively,  $VCoil_e$  is excitation voltage and  $ICoil_s$  is the induced current of the sensing coil, and  $\omega$  is angular frequency.

### 3.2 Model description

The sensor head and the canister geometries were built based on the dimensions of the EMspec™ system provided by Primetals Technology Limited, as shown in Figure 3. The sensor was set to be above a 500×500 mm<sup>2</sup> steel plate with varying thickness. A sphere (radius 5 times the sensor length) is added to encircle the sensor and canister geometries. The added sphere is filled with air in order to simulate the sensor working environment (the air sphere is not shown in Figure 3). The sensor operates at a 40 mm lift off from the sample and the model runs simultaneously at 8 frequencies from 0.375 – 48 kHz. An Auxiliary Sweep was also used in the study to help model convergence at low

frequency. The materials properties used in the model are listed in table 1. The permeability values have been determined for the low magnetic field appropriate for the EMspec™ sensor for different steel microstructures using a FE microstructure model and experimental measurements [4, 7]. The conductivity of air is set at a low value to help the convergence of the model. Numerical multiturn coil function was applied to the exciting and sensing coil domains and a voltage of 3 used for coil excitation. The number of turns for the exciting and sensing coils are both 100. The coil geometry analysis feature is used in the study step and a parametric sweep is used to define different permeability and resistivity values of steel samples.

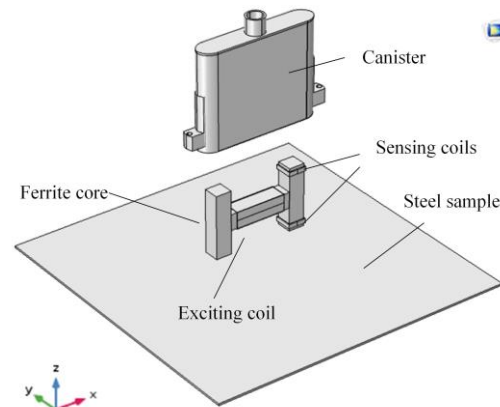

**Figure 3. Geometries of the model (the canister is lifted above the sensor to show the sensor head geometry).**

**Table 1 Magnetic and electrical properties used in the model.**

Materials	Ferrite core	Copper wire	Canister	Air
Conductivity, S/m	1	6×10 <sup>7</sup>	4.2×10 <sup>6</sup>	50
Permeability	2300	1	90	1

### 3.3 Meshing

The full 3D FE model was established and fitting was carried out using measured data (ZCF, permeability and resistivity) for a DPsteel sample. The model was then used to predict the ZCF for a range of other steel grades, which all had relatively low values (< 300) of magnetic permeability at room temperature (dual phase, martensite, low

carbon and ferrite-pearlite samples). Good agreement between the predicted and measured ZCF was obtained for these sample, however this model had limited mesh elements (limited by local computer workstation capability to solve the model: CPU: Intel Xeon E5-1620 3.70GHz; RAM: 64.0 GB) which meant it was unable to accurately predict the ZCF for high permeability samples (e.g. electrical steels or samples at high temperature) when the minimum mesh element was larger than the skin depth. A symmetrical model was developed to reduce the geometry domain such that a finer mesh scheme can be applied to allow the skin depth to be solved while keeping the model hardware requirement reasonable (i.e. suitable for the workstation available). The magnetic insulation boundary was applied to the symmetrical planes of the model.

Figure 4 shows the symmetrical model with meshing. To refine the mesh in the key areas, the Boundary Layer and Swept Mesh method (refining the domain in the thickness direction) were applied to the coil and sample domains. The minimum layer thickness is 0.02 mm, which guarantees there are sufficient mesh elements within the skin depth (skin depth for an electrical sample at 6000 Hz is about 0.08 mm). The total number of elements for the model is of the order of  $1.3 \times 10^6$  and the computing time for one real inductance (phase) vs frequency curve (8 data points), used to obtain the ZCF value, is about 4.0 hours based on using the available workstation.

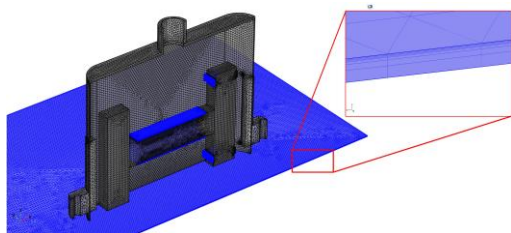
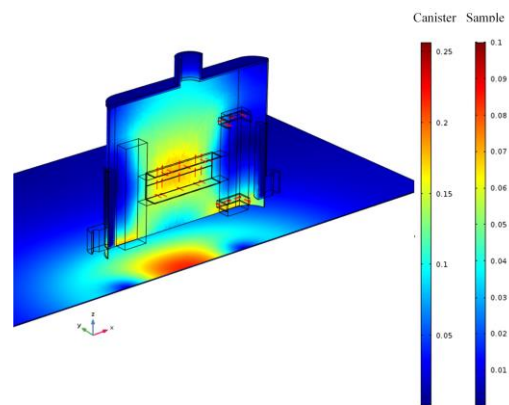

**Figure 4. Symmetrical model with meshing (boundary layer was applied to the coil and sample domains).**

## 4. Results and discussions

### 4.1 Magnetic field

Figure 5 shows the magnetic flux density distributed inside the canister and on the sample surface. The magnetic flux flows from one sensor foot to the other through the sample causing the magnetic flux density in the area between the two sensor feet to be higher than in other areas at the sample surface. It can be seen that the canister is also magnetised by the exciting coil and thus will influence the signal detected by the sensing coil. The magnetic field in the samples was determined to be  $< 0.2$  kA/m, which agrees well with the measured (using a Gauss Meter) value.



**Figure 5. Magnetic field distribution in the sample and the canister; the red arrows indicate coil direction of exciting and sensing coils.**

### 4.2 Model validation

Figure 6 shows the modelled inductance against frequency curves for four steel samples with different thicknesses and different microstructures used for validation. At low frequency, the steel sample is magnetised by the sensors magnetic flux and the inductance is positive (the magnitude of which is affected by the sample permeability and thickness). When frequency increases, eddy currents are generated in the sample. The eddy currents induce a magnetic field, which is opposite to the primary one generated by the sensor, therefore the inductance decreases and the sample resistivity has a strong influence on the sensor signal. At high frequencies, the eddy

currents decrease as the skin depth decreases with the frequency, so the inductance curve gradually levels at a certain value.

Figure 7 shows the modelled ZCF derived from the inductance curve compared with measurements for a wide range of steel grades at room temperature. The figure shows excellent agreement is obtained for the sensor signal (within  $\pm 10\%$  error).

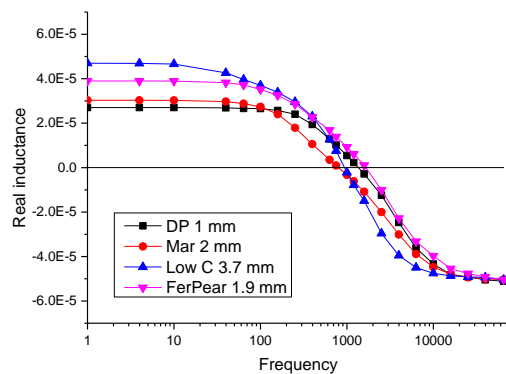

**Figure 6. Modelled inductance for different steel samples at room temperature.**

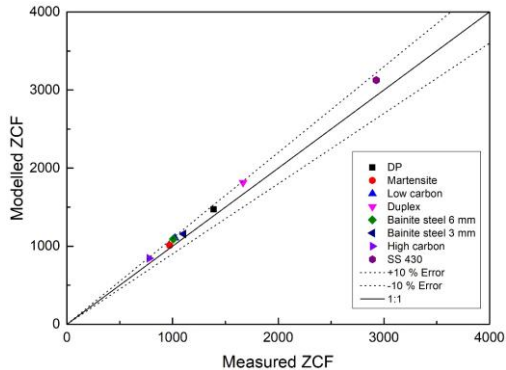

**Figure 7. Modelled and measured ZCF values with  $\pm 10\%$  error.**

#### 4.3 High temperature ZCF prediction

The challenge for the EMspec<sup>TM</sup> sensor application is to be able to measure microstructure (phase fraction) during hot strip steel processing. To demonstrate this capability the ZCF vs temperature curve during cooling for a Cr-Mo steel was predicted (for known transformation conditions) using the FE model. The permeability and resistivity values were obtained from a FE microstructure model and the literature, respectively [4, 7, 8]. The

modelling results were compared with high temperature laboratory measurements using the EMspec<sup>TM</sup> sensor [9]. The microstructure transformation (austenite to bainite) fraction for the steel during cooling was independently measured using dilatometry with the same cooling rate as the lab EMspec<sup>TM</sup> measurement. Figure 8 shows the modelled and measured ZCF for the Cr-Mo steel during cooling. The steel starts to transform at about 525 °C from austenite (paramagnetic) to bainite (ferromagnetic) with transformation being complete at about 385 °C. The measured ZCF increases as the transformation begins and reaches a peak when the steel is fully transformed. The ZCF then decreases due to the decrease of permeability and resistivity at low temperatures. The predicted ZCF follows the same trend as the experimental ZCF and the values agree well with each other. The difference between the modelled and measured ZCF when the transformation fraction  $< 40\%$  may be due to the ferromagnetic phase not being connected in the microstructure at these transformation fractions. Previously it was shown, using a magnetic flux-microstructure model developed in COMSOL [7], that when the magnetic flux is not able to pass continuously through the ferromagnetic phase a lower permeability value than predicted by a rule of mixtures results.

The model also allows the influence of sample geometry (strip thickness, and size – e.g. if microstructure variations close to sample edges are desired), operation (lift off between sample and sensor, temperature) and steel (microstructure) to be assessed and signals to be related to microstructure.

The model can be used in two ways in the future:

1. To determine the transformed fraction in steel during cooling from the measured ZCF (from an EMspec<sup>TM</sup> sensor in the steel mill) and temperature (to obtained

resistivity value). This allows quantitative in-situ monitoring of steel transformation, which cannot currently be measured using existing technology and is inferred from mill models.

2. To provide a desired ZCF trajectory with temperature (or time) to achieve a specific microstructure for real-time control of microstructure development.

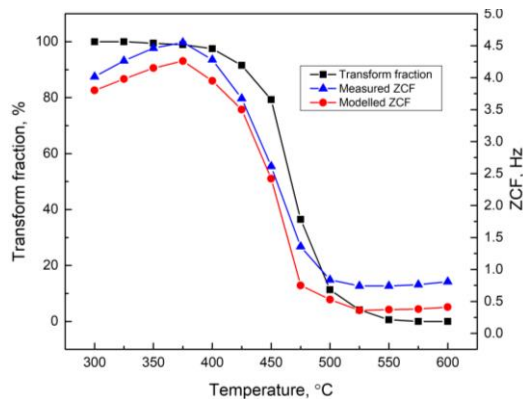

**Figure 8. Modelled and experimental ZCF and transformed fraction with temperature for a Cr-Mo steel.**

## 5. Conclusions

A 3D FE model has been developed for the commercial EMspec<sup>TM</sup> sensor system taking into account the sensor, canister housing, sample properties and geometry. Symmetrical domain and boundary layer mesh were applied to improve model accuracy for high permeability steels or high temperature measurements. The model has been verified against sensor measurements using the EMspec<sup>TM</sup> system for steel samples with different microstructures at room and elevated temperatures. The model can be used to obtain the sample permeability at any (known) temperature (and hence resistivity) from the sensor signal, which can then be used to determine the microstructure (phase fraction), mimicking the real-time monitoring of phase transformation of steel products.

## 6. Acknowledgements

The authors thank Primetals Technologies Limited for supporting this work.

## 7. References

- [1] P. Hunt, et al, "The Real Time Transformation Control at Hot Strip Mill Key Words Engineering the Sensor," in Metec & 2nd Estad, 2015, no. June, pp. 1–9.
- [2] H. Yang, et al, "In-Line Quantitative Measurement of Transformed Phase Fraction by EM Sensors during Controlled Cooling on the Run-Out Table of a Hot Strip Mill," in 19th World Conference on Non-Destructive Testing 2016, pp. 1–8
- [3] J. Shen, et al, "Real-time microstructure control using EMspec sensor" In-line measurement for control of metals processing conference, IoMMM, Warwick, 9-10th December 2017.
- [4] L. Zhou, et al, "Quantification of the phase fraction in steel using an electromagnetic sensor," NDT E Int., vol. 67, pp. 31–35, 2014.
- [5] Lee, Kyunghun, et al. "Prediction and control of front-end curvature in hot finish rolling process." *Advances in Mechanical Engineering* 7.11 (2015): 1687814015615043
- [6] COMSOL Multiphysics the AC/DC module, version: COMSOL 5.3a
- [7] L. Zhou, et al. "Magnetic NDT for steel microstructure characterisation – modelling the effect of second phase distribution on magnetic relative permeability" Proceedings from the 19th World Conference on Non-Destructive Testing (WCNDT 2016), 13-17 June 2016 in Munich, German, published in NDT.net issue Vol.21 No.07 (July 2016) ISSN 1435-4934
- [8] N. Maniar, et al. *Metals Handbook: Volume 1 Properties and Selection: Irons and Steels*, 9th ed. American Society For Metals, 1978.
- [9] W. Jacobs et al, "Measurement and modelling of the EMspec<sup>TM</sup> sensor response to phase transformation in 2.25 Cr-Mo steel" BINDT 2018.

